	<b>SPECIFICATION</b>	Model No.	CRT-571
		Date	2010/06/25
	<b>Card Dispenser</b>	Ver.	1.0
		Page	1/25

# PRODUCT SPECIFICATION

## CRT-571

### Card Issuing Machine

VER 1.0



#### CREATOR (CHINA) TECH CO., LTD.

•Add: 2F, M-10 Building, Center Area, Hi-tech Industrial Park, Shenzhen, China

•TEL:+86 755 26710691      FAX:+86 755 26710105

•Http://www.china-creator.com

	SPECIFICATION	Model No.	CRT-571
		Date	2010/06/25
	Card Dispenser	Ver.	1.0
		Page	2/25

## Main Structure of CRT-571

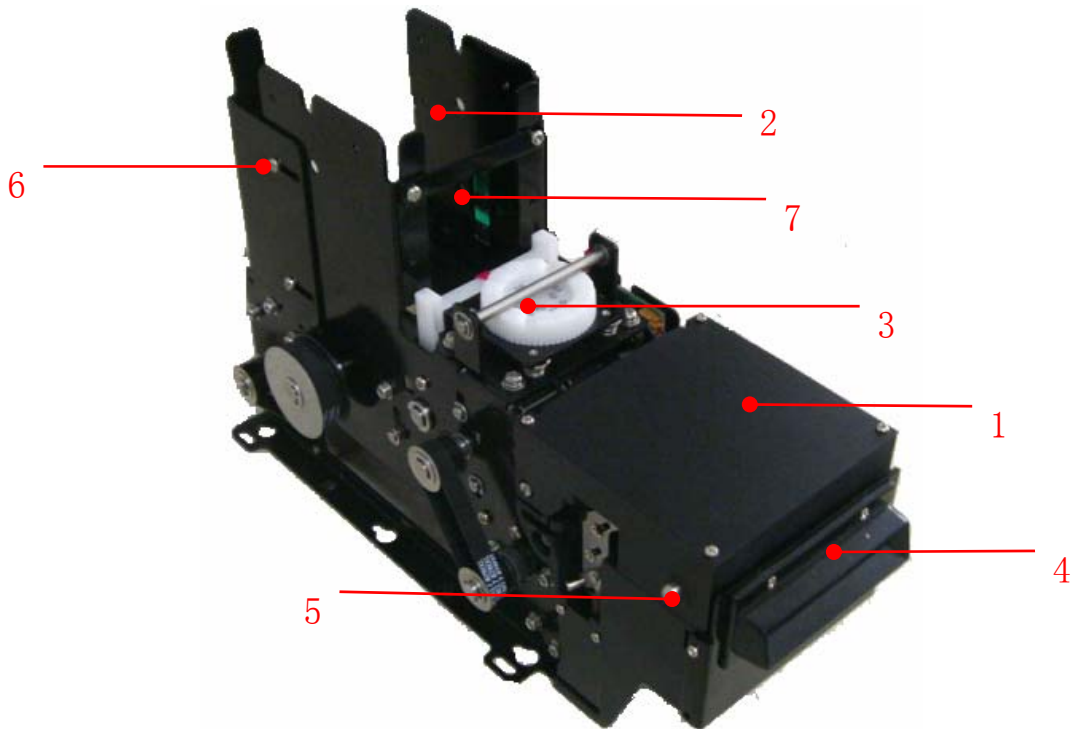

1-----Read/Write Components

2-----Issuing Components

3-----Card Thickness Adjustment

4-----Shutter Components ( Optional )

5-----Bottom to open up cover of read/write components

6-----Blade for removable stacker

7-----Metal bar for removable stacker

	SPECIFICATION	Model No.	CRT-571
		Date	2010/06/25
	Card Dispenser	Ver.	1.0
		Page	3/25

## CONTENTS

<b>1.</b>	<b>OVERVIEW .....</b>	<b>5</b>
<b>2.</b>	<b>Main Functions .....</b>	<b>6</b>
<b>3.</b>	<b>Technical Specification .....</b>	<b>7</b>
<b>4.</b>	<b>Product Module Number Specification .....</b>	<b>8</b>
<b>5.</b>	<b>Interface Specification .....</b>	<b>9</b>
<b>6.</b>	<b>Photoelectric Sensor Specification .....</b>	<b>11</b>
<b>7.</b>	<b>Card Stop Drawing .....</b>	<b>11</b>
<b>8.</b>	<b>DIP Setting Of Unit Address .....</b>	<b>12</b>
<b>9.</b>	<b>Card Thickness Adjustment Specification .....</b>	<b>13</b>
<b>10.</b>	<b>DEMO Operation .....</b>	<b>15</b>
<b>11.</b>	<b>Maintenance .....</b>	<b>18</b>
<b>12.</b>	<b>Cautions .....</b>	<b>19</b>
<b>13.</b>	<b>Reference Document .....</b>	<b>21</b>
<b>14.</b>	<b>Structure and Dimension Drawing .....</b>	<b>22</b>
<b>Annex 1: Structure Drawing of CRT-571 with Removable Stacker ..</b>		<b>23</b>
<b>Annex 2. Structure Drawing of Removable Stacker .....</b>		<b>24</b>

	SPECIFICATION	Model No.	CRT-571
		Date	2010/06/25
	Card Dispenser	Ver.	1.0
		Page	4/25

## Revision Log

Version	Revision Time	Content
1.0	2010.1.25	First Release
1.0	2010.6.25	Specification modification: 1. Add Demo specification 2. Add cautions 3. Add maintainence 4. Add Interface Specification

	SPECIFICATION	Model No.	CRT-571
		Date	2010/06/25
	Card Dispenser	Ver.	1.0
		Page	5/25

## 1. OVERVIEW

CRT-571 is card issuing machine with IC/RFID card reader.

CRT-571 has the following features:

- Stacker: Equip with removable stacker. As well, it can issue cards independently without the removable stacker.
- Removable stacker with lock: The cards can be locked in the removable stacker.
- Removable stacker can be locked to the machine body to prevent stolen.
- Concave style of card thickness adjustment.
- Customization Options: PC/SC
- Multi-units communication: Support Max.16 sets of CRT-571.
- Compact size and low cost: One of the most compact card issuing machines with IC/RFID card module

	SPECIFICATION	Model No.	CRT-571
		Date	2010/06/25
	Card Dispenser	Ver.	1.0
		Page	6/25

## 2. Main Functions

- Combination of card issuing and IC/RFID card encoding
- Card-Empty, Pre-card empty detection with audible alarm
- Two method of retract card: Error card bin and path (By removing the bars on the bottom)
- Concaved card thickness adjustment: Patent technology, easy handling
- Support Multi-communication via RS232 interface
- Card capture function and RFID card read/write

	SPECIFICATION	Model No.	CRT-571
		Date	2010/06/25
	Card Dispenser	Ver.	1.0
		Page	7/25

### 3. Technical Specification

- **Power Supply:**  
DC 24V  $\pm$ 5%
- **Current Consumption:**  
Static Current: 0.2A  
Peak Current during Operation: 2.0A  
(1.5A while moving the card)—Pay attention to selection of power supply.
- **Card Feeding-Out Speed:**  
Approx. 14.8cm/s
- **Communication Interface:**  
RS232C / USB (HID) (Ex-work setting: Multi-Communication No. 00)
- **Card Dimensions:**  
Size: 53.92~54.18mm  $\times$  85.47~85.90mm  
Thickness: 0.4mm~1.0mm (Ex-work standard: 0.8mm)
- **Net Weight:**  
Approx. 2.0 Kg (Accessory and package is not accounted)
- **Dimensions:**  
Refer to Structure and Dimension Drawings
- **Card Stacking Capability:**  
120pcs in case of 0.76mm standard card (Without extension)  
(Available load 500 pieces of card max. if there is removable stacker)
- **Card Pre-Empty Detection:**  
7~50pcs  $\pm$  2pcs (Default setting: 15pcs)
- **Environmental Condition:**  
Operation: 0~50°C 0~90% RH ( Without Condensing)  
Storage: -10~75°C 0~90% RH ( Without Condensing)
- **Life Time:**  
500 thousand times  
( In the condition: 20+/-5°C, 35~60%RH, Dispense cycle  $\leq$  1pcs/min)
- **Support On Line ISP Download**
- **Compliant To RoHS**

	<b>SPECIFICATION</b>	Model No.	CRT-571
		Date	2010/06/25
	<b>Card Dispenser</b>	Ver.	1.0
		Page	8/25

#### 4. Product Module Number Specification

CRT - 571 - ( X X X ) X X - X X X X

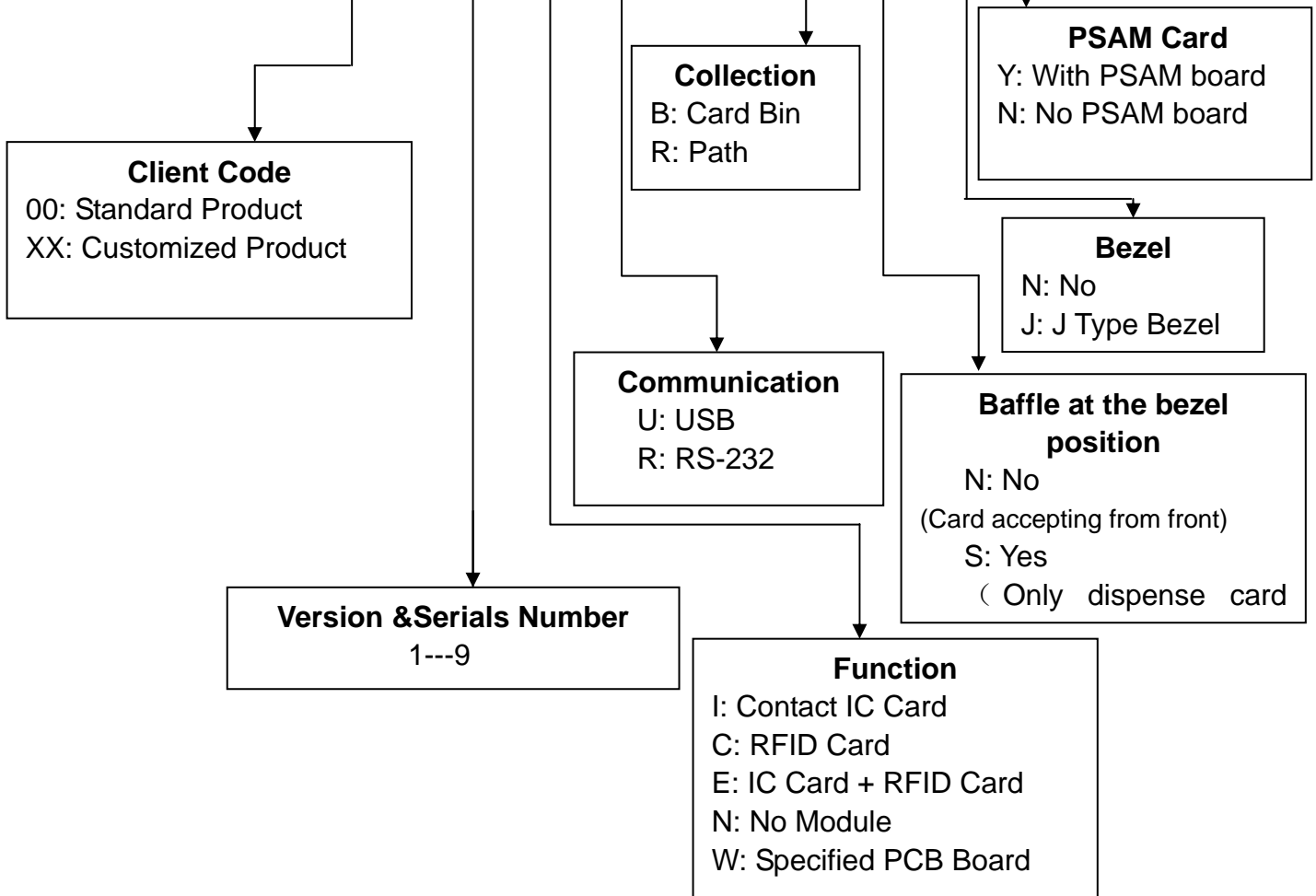

● **Accessory Description**

Name	Model Number	Qty	Notes
571 Block Parts	0517-0A68	1	-----
4PIN Power Cable	L14-333-153	1	4PIN connector and length of 1.5m
RS232 Signal Cable	L10-006-163	1	3PIN connector and length of 1.6m

● **Optional Accessory**

- Long removable stacker with lock: CRT-500-X5L (Capability: 500pcs)
- Long removable stacker without lock: CRT-500- X5N (Capability: 500pcs)
- Short removable stacker with lock: CRT-500- X2L (Capability: 240pcs)
- Short removable stacker without lock: CRT-500- X2N (Capability: 240pcs)



	SPECIFICATION	Model No.	CRT-571
		Date	2010/06/25
	Card Dispenser	Ver.	1.0
		Page	9/25

## 5. Interface Specification

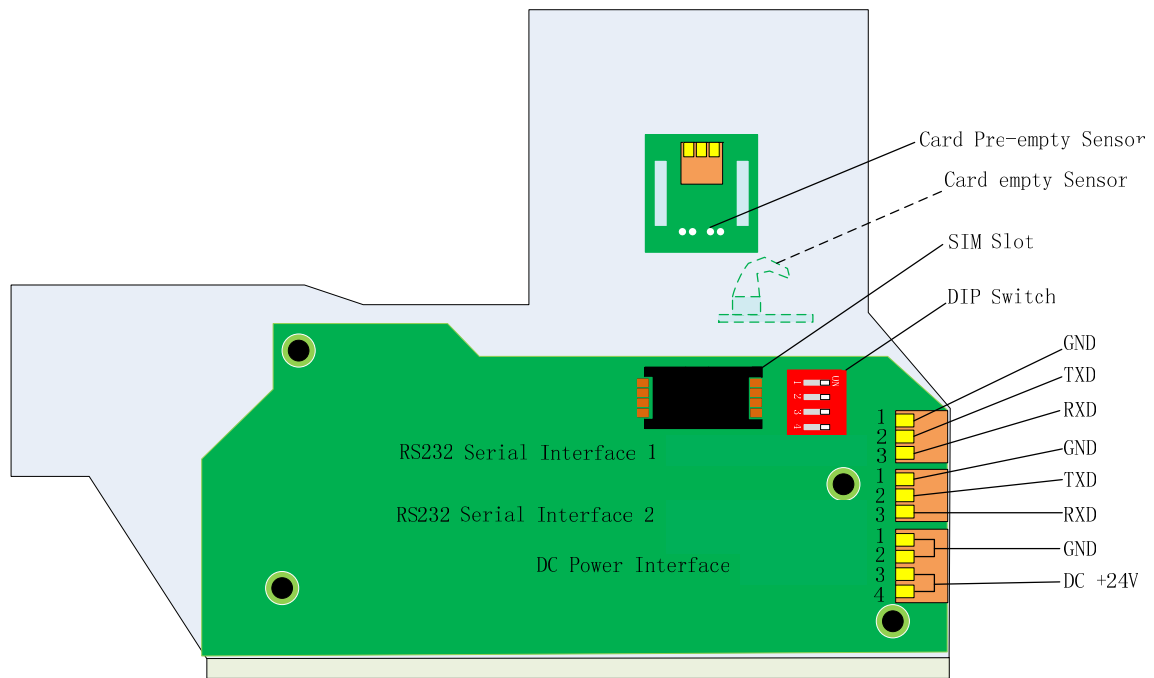

Picture1. CRT-571 Interface sketch map

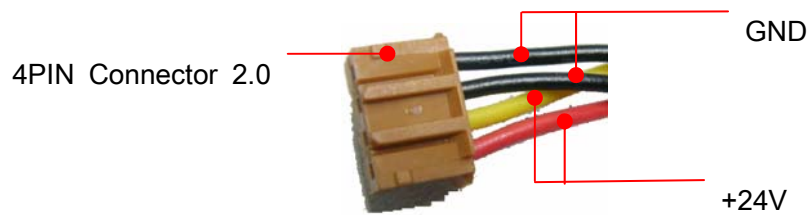

Picture2. 4 PIN Power

	<b>SPECIFICATION</b>	Model No.	CRT-571
		Date	2010/06/25
	<b>Card Dispenser</b>	Ver.	1.0
		Page	10/25

- 1. Brown
- 2. Red
- 3. Orange

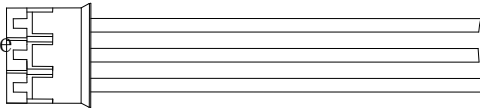

PC DB9 PIN Connector

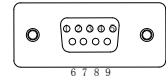

1	RXD
2	TXD
3	GND

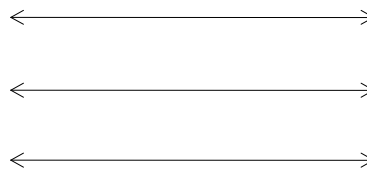

2	TXD
3	RXD
5	GND

Picture3. Connection between 3 pin com cable and PC DB9 pin connector

	SPECIFICATION	Model No.	CRT-571
		Date	2010/06/25
	Card Dispenser	Ver.	1.0
		Page	11/25

## 6. Photoelectric Sensor Specification

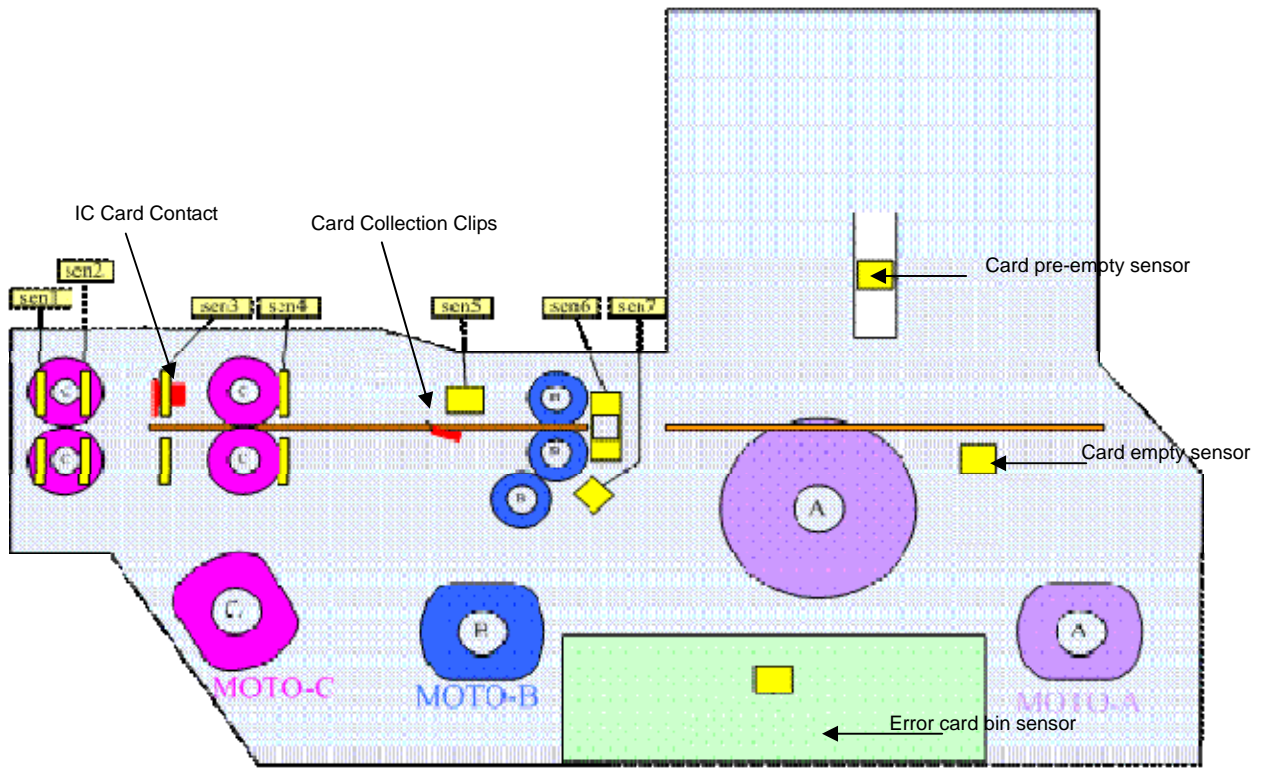

## 7. Card Stop Position Drawing

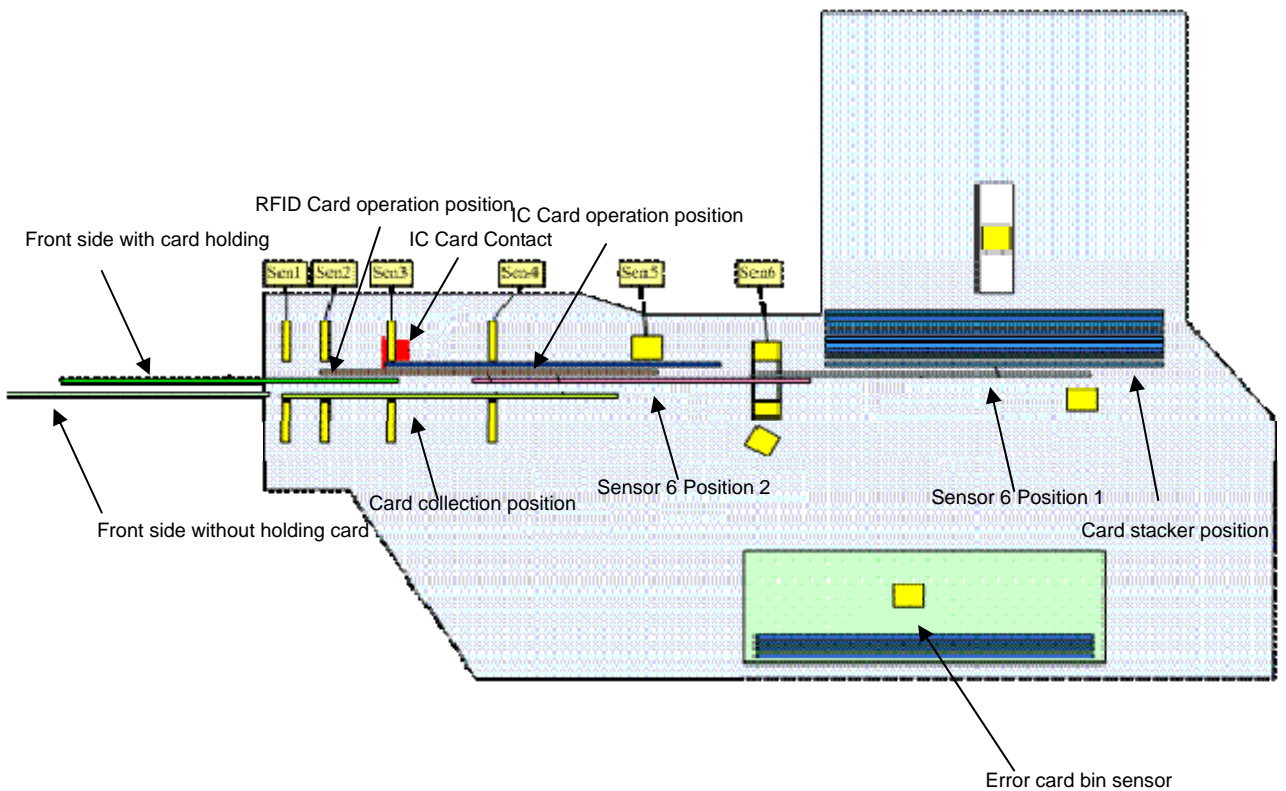

	SPECIFICATION	Model No.	CRT-571
		Date	2010/06/25
	Card Dispenser	Ver.	1.0
		Page	12/25

## 8. DIP Setting Of Unit Address

The following table shows the Dip setting of Unit Address.

Multi-switch				Corresponding address
4	3	2	1	
ON	ON	ON	ON	'00'
ON	ON	ON	OFF	'01'
ON	ON	OFF	ON	'02'
ON	ON	OFF	OFF	'03'
ON	OFF	ON	ON	'04'
ON	OFF	ON	OFF	'05'
ON	OFF	OFF	ON	'06'
ON	OFF	OFF	OFF	'07'
OFF	ON	ON	ON	'08'
OFF	ON	ON	OFF	'09'
OFF	ON	OFF	ON	'10'
OFF	ON	OFF	OFF	'11'
OFF	OFF	ON	ON	'12'
OFF	OFF	ON	OFF	'13'
OFF	OFF	OFF	ON	'14'
OFF	OFF	OFF	OFF	'15'

	SPECIFICATION	Model No.	CRT-571
		Date	2010/06/25
	Card Dispenser	Ver.	1.0
		Page	13/25

## 9. Card Thickness Adjustment Specification

### 1) Card Thickness Gear

Gear	Range of Thickness ( mm )	Error Rate
0.4	0.36 ~ 0.55	<1/1000
0.6	0.56 ~ 0.7	<1/1000
0.8	0.71 ~ 1.0	<1/1000

#### Notes:

1. The error rate result is based on perfect card which is firmly comply with ISO standard
2. Ignore the thickness of embossed card if emboss is complied with ISO standard. And embossment is always on the top and keeps to right of stacker (the shutter is on the forth) when issuing embossed cards.

	SPECIFICATION	Model No.	CRT-571
		Date	2010/06/25
	Card Dispenser	Ver.	1.0
		Page	14/25

## 2) Adjustment Instruction

CRT-571 makes it more accurate and convenient to dispense the cards in different thickness via rotating the turn-knob to different gear position so as to adjust the gap between the upper and lower transmitting wheels, which eliminates the inconvenient and inaccurate gap adjustment defects. With this feature, CRT-571 is quite suitable for the unattended vending devices to dispense various cards of distinct thickness.

There are several steps to adjust the thickness of cards:

1. Confirm the thickness of cards (Regardless of thickness of embossed card, do not combine different thickness card together)
2. Press the turn-knob and turn around to the graduation pointed by the red arrow. Seeing pictures below.
3. Make sure the adjustment on the right position by insert cards from stacker. (Inserting one card from stacker will be smooth and two cards simultaneously from behind can be impossible)

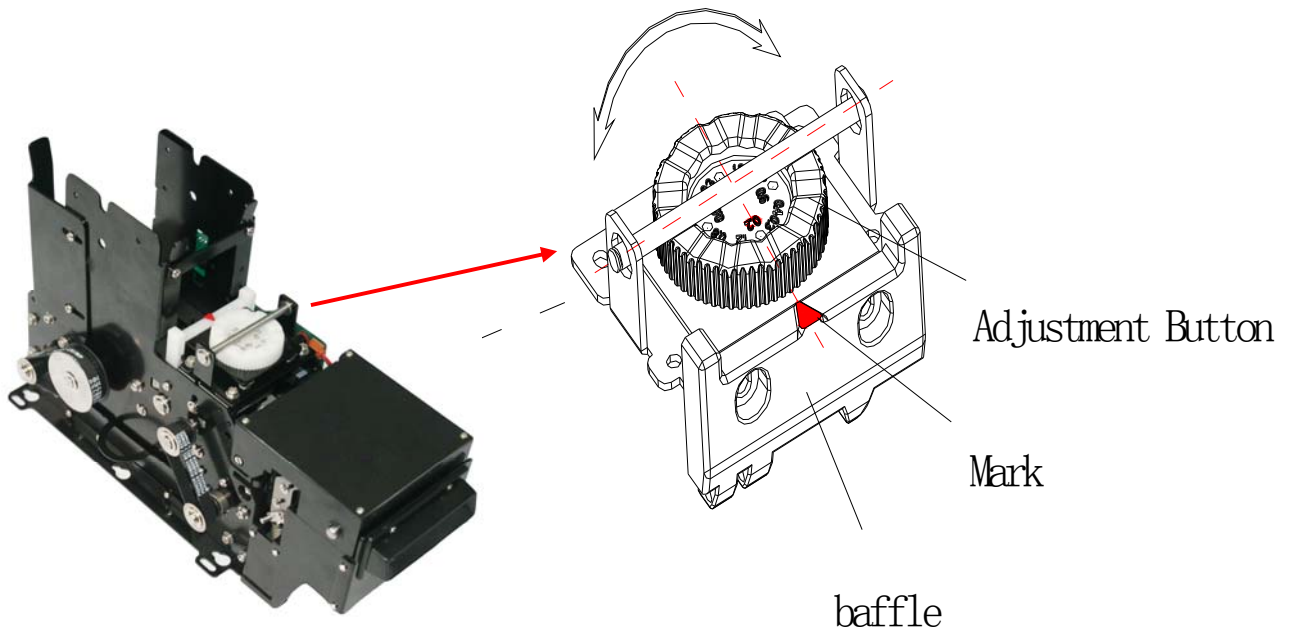

	SPECIFICATION	Model No.	CRT-571
		Date	2010/06/25
	Card Dispenser	Ver.	1.0
		Page	15/25

## 10. DEMO Operation

### 1) Connection Correctly

Firstly plug 3pin communication cable on PCB board, and then plug 4pin power cable. Pay attention to the input voltage (24V).

### 2) Demo Installation

Demo's installation documents are as the behind.

Double click on CTEST571\_V1.0\_EN\_SETUP.EXE or CTEST571\_V1.0\_CN\_SETUP.EXE. The installation will create a shortcut icon on your desk and program column.



Double click to install demo

### 3) Use Demo to Test The Reader

- ① Double click the demo program's shortcut on your desk.
- ② After demo is launched , click 'Enter' to enter operation interface

( as following )

Double Click on DEMO

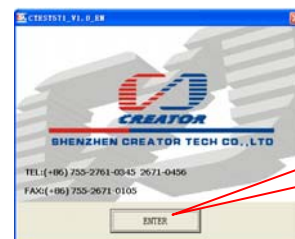

Enter

	SPECIFICATION	Model No.	CRT-571
		Date	2010/06/25
	Card Dispenser	Ver.	1.0
		Page	16/25

③ Com port setting and Initialization : Reader need to be initialized before usage. Please follow these steps as below.

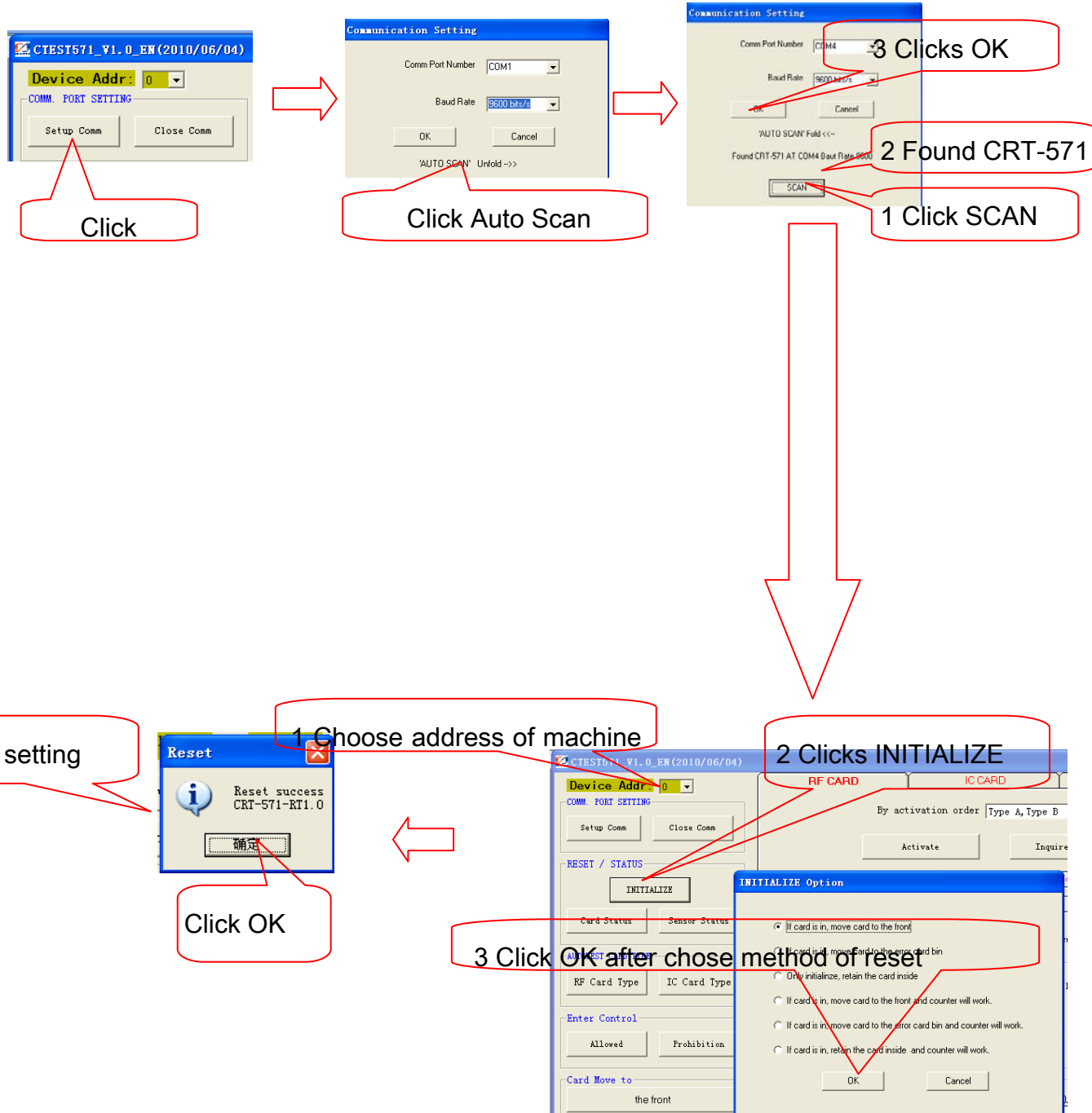



	SPECIFICATION	Model No.	CRT-571
		Date	2010/06/25
	Card Dispenser	Ver.	1.0
		Page	17/25

④ Card Movement Operation and IC card Read/Write

Move card to the front, the front hold the card, RFID card operation position, the IC card operation position, Error card bin. Please move the card to the corresponding position to read IC card and RFID card, and then click auto test type.

Please refer to following photo.

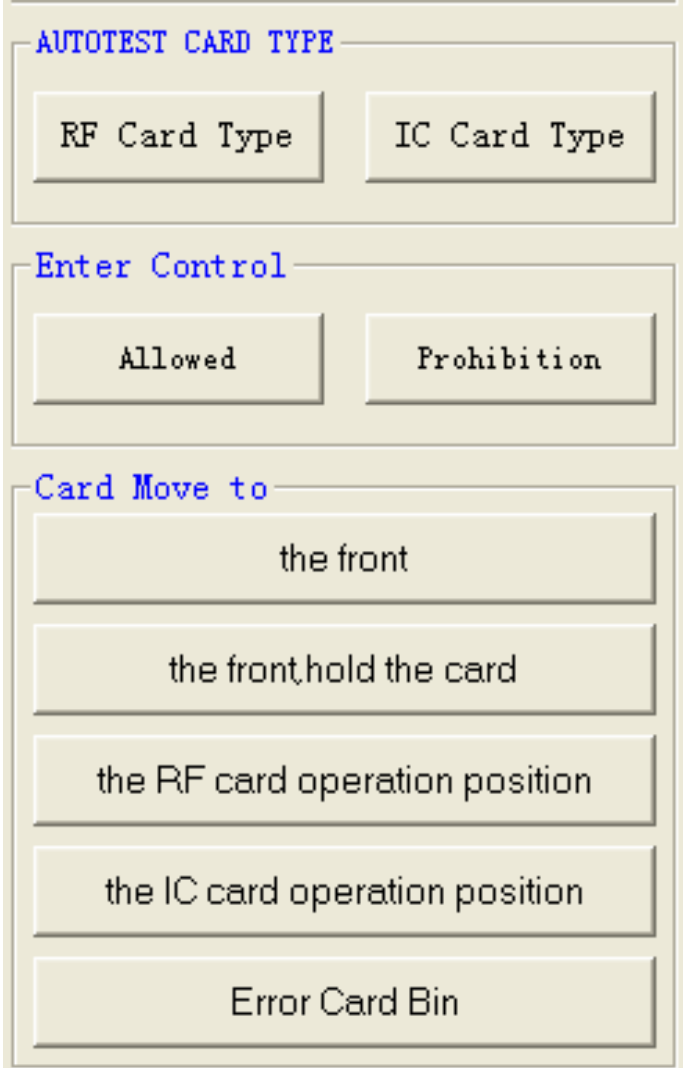

The screenshot shows a menu titled "AUTOTEST CARD TYPE" with three main sections:

- AUTOTEST CARD TYPE**: Contains two buttons: "RF Card Type" and "IC Card Type".
- Enter Control**: Contains two buttons: "Allowed" and "Prohibition".
- Card Move to**: Contains five buttons: "the front", "the front,hold the card", "the RF card operation position", "the IC card operation position", and "Error Card Bin".

⑤ Card Capture Setting:

Machine is allowed to capture card if the allowance of this function is activated.

	SPECIFICATION	Model No.	CRT-571
		Date	2010/06/25
	Card Dispenser	Ver.	1.0
		Page	18/25

## 11. Maintenance

After a long time usage, factors such as the machine's transportation mechanism wear and tear, dust on sensor, magnetic head, IC card contact will influence the performance of the machine, and hence it should be maintained on a constant basis.

Detail maintenance instruction is as following:

① Use a cleaning card or a cloth with alcohol to clean the card dispensing mechanism and card read/write mechanism. (To open the card read/write components please refer to chapter 12"Caution")

② Pick out greasy card and deformed card, and clean the greasy card with soft cloth tapped cleaning alcohol. If the deformed card is unable to restore, it is necessary to replace this deformed card with normal one.

③ Keep card pre-empty sensor clean by soft cloth with cleaning alcohol.

④ Sensor maintenance: Use the sensor status inquiry command to examine sensors' status. When the reader is running under good condition, all its 10 sensor groups' status are 'OFF'; If any sensor group's status is 'ON', it is possible to be covered by dust; You can try to clean the sensor, especially this sensor group.

⑤ IC card contact maintenance: Clean the IC card contact if there is any dirty on them.

⑥ Transportation roll maintenance: Transportation roll should be check regularly and clean by cleaning alcohol if there is any dirty.

	SPECIFICATION	Model No.	CRT-571
		Date	2010/06/25
	Card Dispenser	Ver.	1.0
		Page	19/25

## 12. Cautions

- 1) Before maintenances, make sure the power connection is cut off in order to avoid machine damage.
- 2) Pay attention to DIP specification, wrong DIP number will bring about no work and unknown status.
- 3) Prohibit warm plug in and out of connector. Warm plug will cause circuit damage.
- 4) Keep machine non-greasy, oily cohesive will deadly influence the performance of machine.
- 5) Pay attention to the IC card direction in stack. (See following picture)

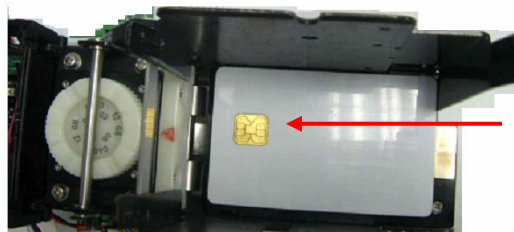

The position of IC card

Picture the correct position of IC card in stack

- 6) Pay attention to the power off sequence, cut off power first and then cut off communication cable.
- 7) To open/close the card read/write component
  - ① Open the cover of read/write component: Push the button on the both side of machine (See picture). And make sure the button is push to the end.
  - ② Pull up the cover of read/write component and clean the rubber wheel, photoelectric sensor and IC card contact.
  - ③ Restore the cover of read/write component: Push the button on the both side of machine (See picture4) and pull down the cover to original place and loose your hand. Make sure the cover is in the correct place.

	SPECIFICATION	Model No.	CRT-571
		Date	2010/06/25
	Card Dispenser	Ver.	1.0
		Page	20/25

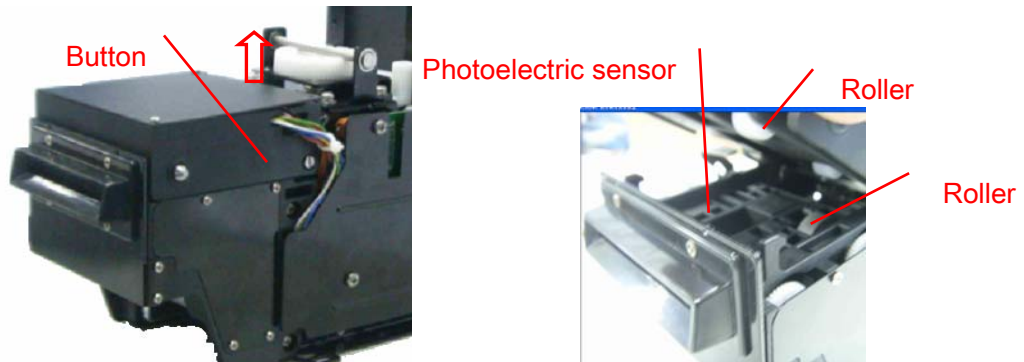

Picture4. To open RFID/IC card component

## 8) Removable stacker

- ① Unscrew two M3x3 screws to get rid of blade of stable stacker.( See picture 5)
- ② Loading the removable stacker and make sure the removable stacker is in place.

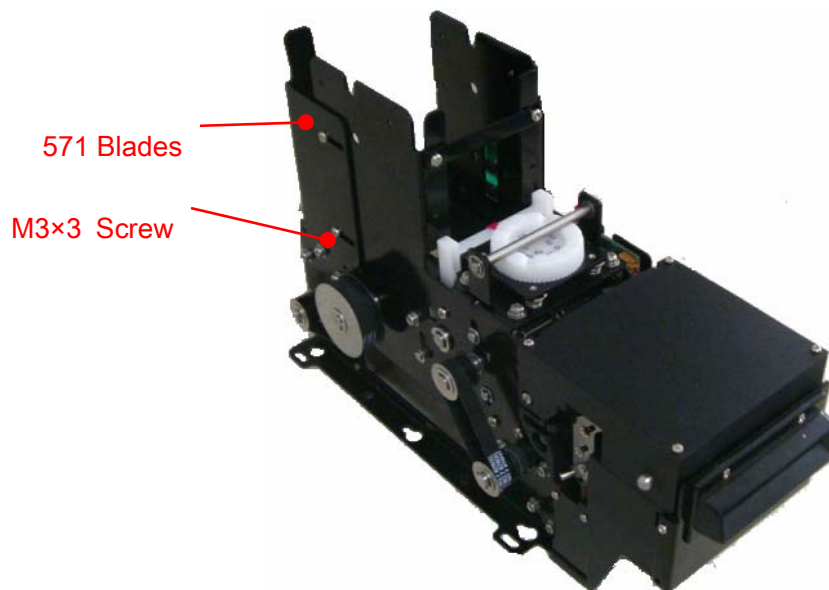

Picture5. Loading of removable stacker

	<b>SPECIFICATION</b>	Model No.	CRT-571
		Date	2010/06/25
	<b>Card Dispenser</b>	Ver.	1.0
		Page	21/25

### 13. Reference Document

- ① DLL
- ② DLL Specification and example
- ③ Communication protocol

	SPECIFICATION	Model No.	CRT-571
		Date	2010/06/25
	Card Dispenser	Ver.	1.0
		Page	22/25

## 14. Structure and Dimension Drawing

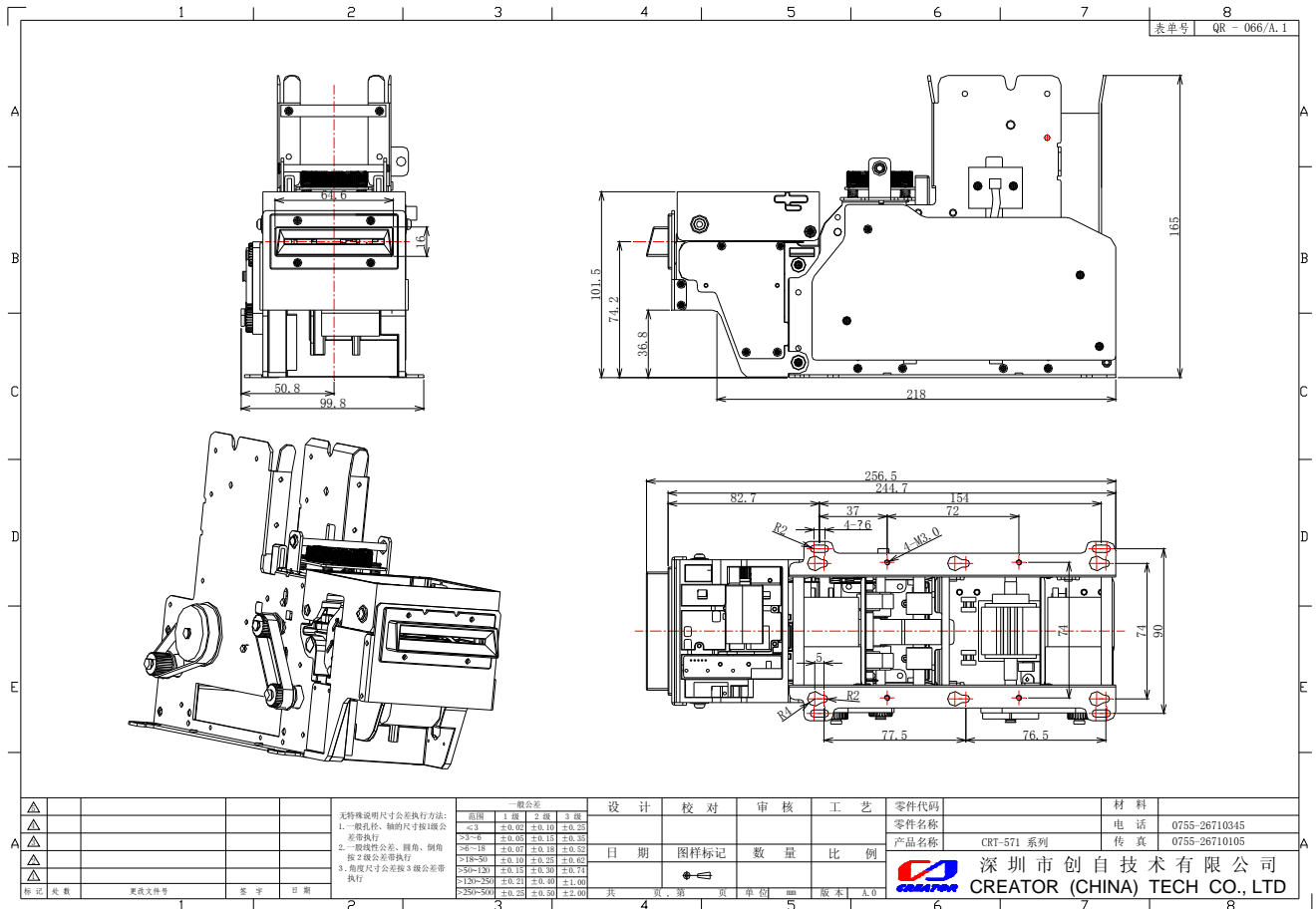

	SPECIFICATION	Model No.	CRT-571
		Date	2010/06/25
	Card Dispenser	Ver.	1.0
		Page	23/25

### Annex 1: Structure Drawing of CRT-571 with Removable Stacker

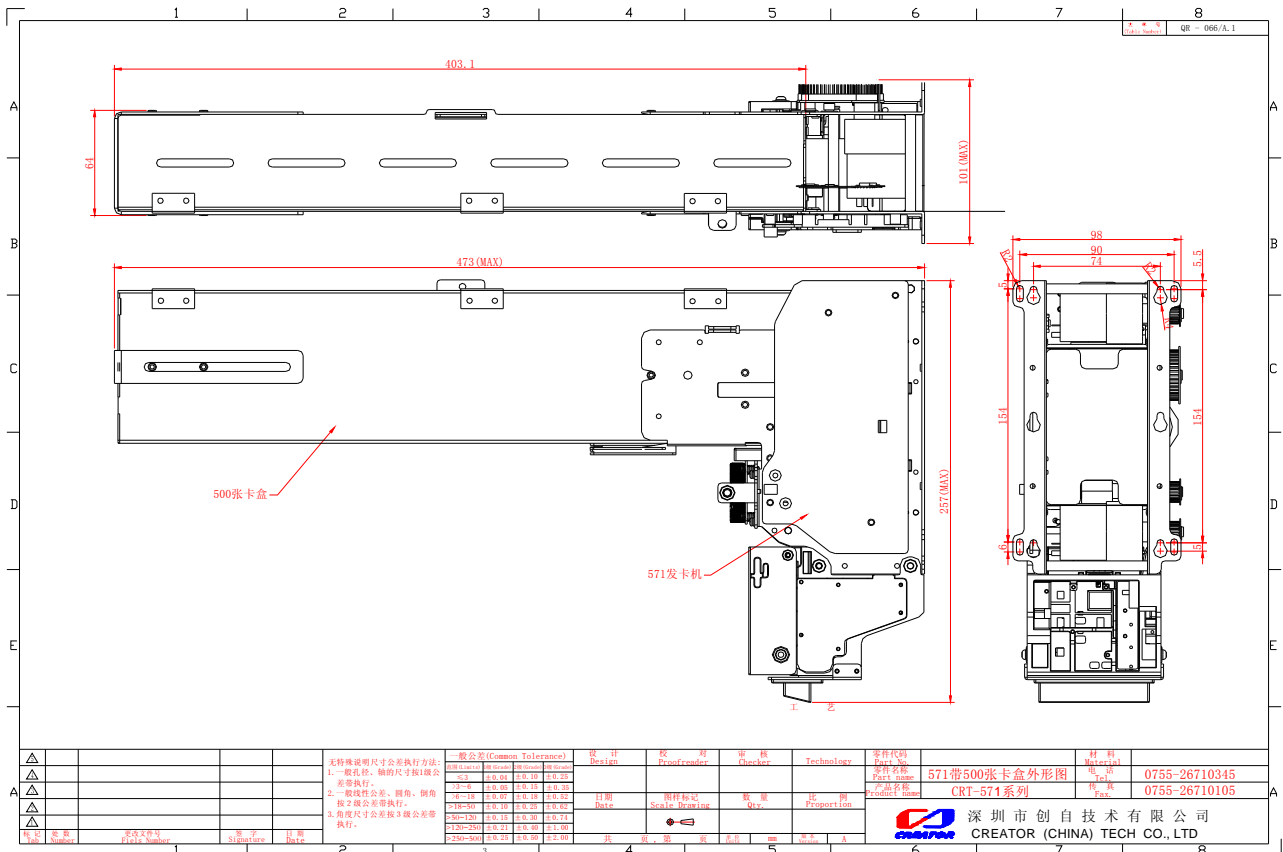
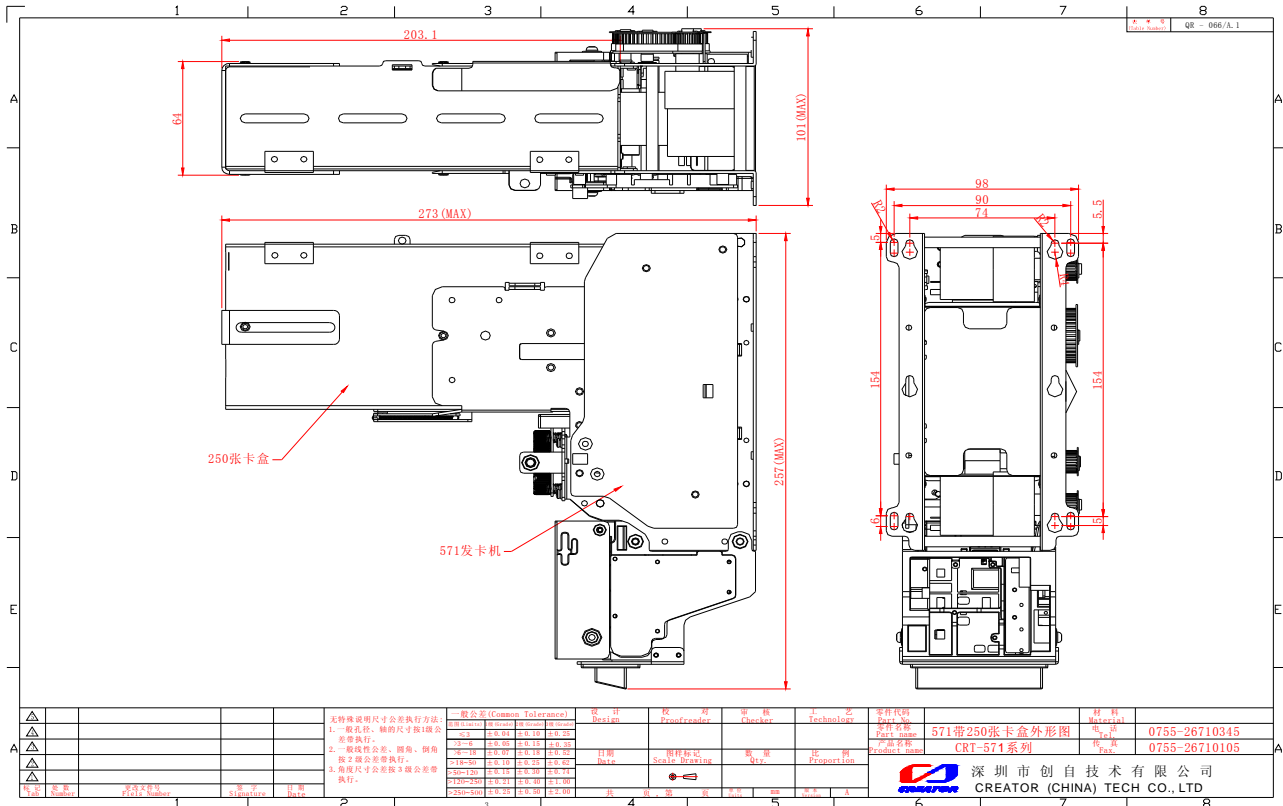

	SPECIFICATION	Model No.	CRT-571
		Date	2010/06/25
	Card Dispenser	Ver.	1.0
		Page	24/25

## Annex 2. Structure Drawing of Removable Stacker

